

Аксиальные держатели при левом вращении шпинделя

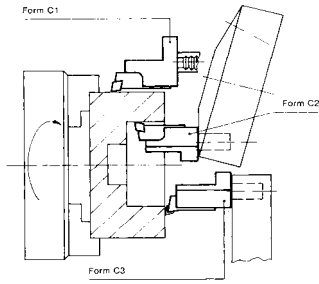

Радиальные держатели при левом вращении шпинделя

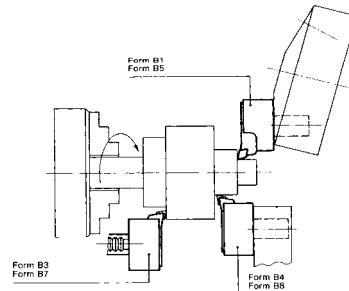

Аксиальные держатели при правом вращении шпинделя

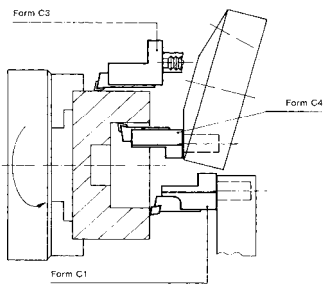

Радиальные держатели при правом вращении шпинделя

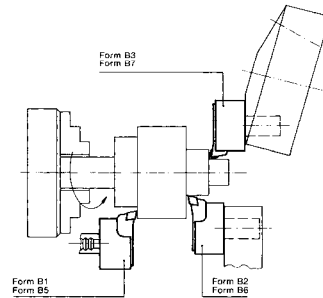

Тип А1, Заготовка

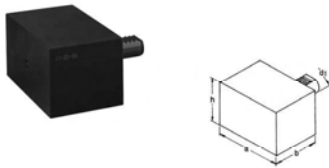

d1 mm	a mm	h mm	b mm	склад	№ для заказа
					47-A1
16	78	44	44	•	-16-44
20	100	60	65	•	-20-65
25	100	60	75	•	-25-75
30	130	76	85	•	-30-85
40	151	96	100	•	-40-100

Тип А2, Заготовка



d1 mm	d2 mm	b mm	склад	№ для заказа
				47-A2
16	40	60	•	-16-60
20	50	70	•	-20-70
25	58	80	•	-25-80
25	58	200	•	-25-200
30	68	100	•	-30-100
30	68	240	•	-30-240
40	83	120	•	-40-120
40	83	320	•	-40-320
50	98	135	•	-50-135
50	98	400	•	-50-400
60	123	150	•	-60-150
60	123	480	•	-60-480

Тип В1, Радиальный держатель, правый, короткий

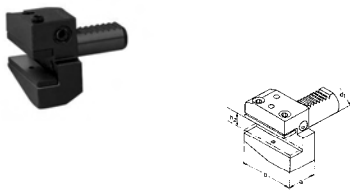

d1 mm	h2 mm	a mm	b mm	склад	№ для заказа
					47-B1
16	10/12	24	42	•	-16-12
20	12/16	30	55	•	-20-16
25	12/16	30	55	•	-25-16
30	16/20	40	70	•	-30-20
40	20/25	44	85	•	-40-25
50	25/32	55	100	•	-50-32
60	25/32	60	125	•	-60-32

пример заказа держателя В1, VDI30: 47B1-30-20

Тип В2, Радиальный держатель, левый, короткий

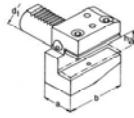

d1 mm	h2 mm	a mm	b mm	склад	№ для заказа
					47-B2
16	10/12	24	42	•	-16-12
20	12/16	30	55	•	-20-16
25	12/16	30	55	•	-25-16
30	16/20	40	70	•	-30-20
40	20/25	44	85	•	-40-25
50	25/32	55	100	•	-50-32
60	25/32	60	125	•	-60-32

Тип В3, Радиальный держатель, перевернутый, правый, короткий

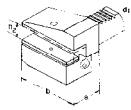

d1 mm	h2 mm	a mm	b mm	склад	№ для заказа
					47-B3
16	10/12	24	42	•	-16-12
20	12/16	30	55	•	-20-16
25	12/16	30	55	•	-25-16
30	16/20	40	70	•	-30-20
40	20/25	44	85	•	-40-25
50	25/32	55	100	•	-50-32
60	25/32	60	125	•	-60-32

Тип В4, Радиальный держатель, перевернутый, левый, короткий

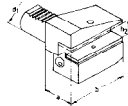

d1 mm	h2 mm	a mm	b mm	склад	№ для заказа
					47-B4
16	10/12	24	42	•	-16-12
20	12/16	30	55	•	-20-16
25	12/16	30	55	•	-25-16
30	16/20	40	70	•	-30-20
40	20/25	44	85	•	-40-25
50	25/32	55	100	•	-50-32
60	25/32	60	125	•	-60-32

Тип В5, Радиальный держатель, правый, длинный

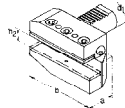

d1 mm	h2 mm	a mm	b mm	склад	№ для заказа
					47-B5
16	10/12	24	58	•	-16-12
20	12/16	30	75	•	-20-16
25	12/16	30	75	•	-25-16
30	16/20	40	100	•	-30-20
40	20/25	44	118	•	-40-25
50	25/32	55	130	•	-50-32
60	25/32	60	145	•	-60-32

Тип В6, Радиальный держатель, левый, длинный



d1 mm	h2 mm	a mm	b mm	склад	№ для заказа
					47-B6
16	10/12	24	58	•	-16-12
20	12/16	30	75	•	-20-16
25	12/16	30	75	•	-25-16
30	16/20	40	100	•	-30-20
40	20/25	44	118	•	-40-25
50	25/32	55	130	•	-50-32
60	25/32	60	145	•	-60-32

Тип В7, Радиальный держатель, перевернутый, правый, длинный

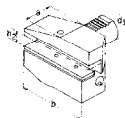

d1 mm	h2 mm	a mm	b mm	склад	№ для заказа
					47-B7
16	10/12	24	58	•	-16-12
20	12/16	30	75	•	-20-16
25	12/16	30	75	•	-25-16
30	16/20	40	100	•	-30-20
40	20/25	44	118	•	-40-25
50	25/32	55	130	•	-50-32
60	25/32	60	145	•	-60-32

Тип В8, Радиальный держатель, перевернутый, правый, длинный

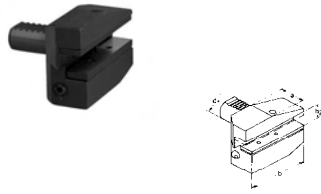

d1 mm	h2 mm	a mm	b mm	склад	№ для заказа
					47-B8
16	10/12	24	58	•	-16-12
20	12/16	30	75	•	-20-16
25	12/16	30	75	•	-25-16
30	16/20	40	100	•	-30-20
40	20/25	44	118	•	-40-25
50	25/32	55	130	•	-50-32
60	25/32	60	145	•	-60-32

Тип С1, Аксиальный держатель, правый

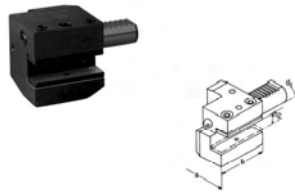

d1 mm	h2 mm	b mm	a mm	склад	№ для заказа
					47-C1
16	10/12	44	43	•	-16-12
20	12/16	50	52	•	-20-16
25	12/16	55	58	•	-25-16
30	16/20	70	76	•	-30-20
40	20/25	85	85	•	-40-25
50	25/32	100	100	•	-50-32
60	25/32	125	125	•	-60-32

Тип С2, Аксиальный держатель, левый



d1 mm	h2 mm	b mm	a mm	склад	№ для заказа
					47-C2
16	10/12	44	43	•	-16-12
20	12/16	50	52	•	-20-16
25	12/16	55	58	•	-25-16
30	16/20	70	76	•	-30-20
40	20/25	85	85	•	-40-25
50	25/32	100	100	•	-50-32
60	25/32	125	125	•	-60-32

Тип С3, Аксиальный держатель, правый, перевернутый

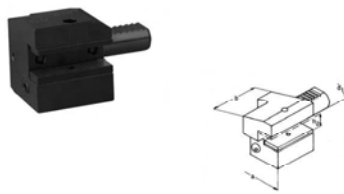

d1 mm	h2 mm	b mm	a mm	склад	№ для заказа
					47-C3
16	10/12	44	43	•	-16-12
20	12/16	50	52	•	-20-16
25	12/16	55	58	•	-25-16
30	16/20	70	76	•	-30-20
40	20/25	85	85	•	-40-25
50	25/32	100	100	•	-50-32
60	25/32	125	125	•	-60-32

Тип С4, Аксиальный держатель, левый, перевернутый

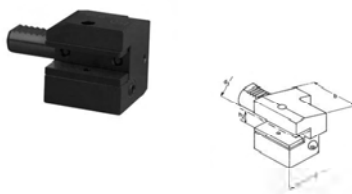

d1 mm	h2 mm	b mm	a mm	склад	№ для заказа
					47-C4
16	10/12	44	43	•	-16-12
20	12/16	50	52	•	-20-16
25	12/16	55	58	•	-25-16
30	16/20	70	76	•	-30-20
40	20/25	85	85	•	-40-25
50	25/32	100	100	•	-50-32
60	25/32	125	125	•	-60-32

Тип D1, Универсальный держатель



d1 mm	h2 mm	b mm	a mm	склад	№ для заказа
					47-D1
25	12/16	48	66	•	-25-16
30	16/20	60	76	•	-30-20
40	20/25	72	90	•	-40-25
50	25/32	85	105	•	-50-32

Тип D2, Универсальный держатель, перевернутый

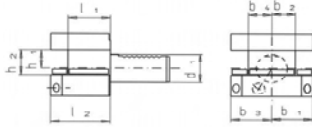

d1 mm	h1/h2 mm	b mm	a mm	склад	№ для заказа
					47-D2
25	12/16	48	66	•	-25-16
30	16/20	60	76	•	-30-20
40	20/25	72	90	•	-40-25
50	25/32	85	105	•	-50-32

Держатель отрезных резцов, правый

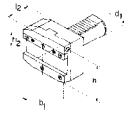

d1 mm	b1 mm	h mm	l2 mm	h2 mm	склад	№ для заказа
						47-AR
30	70	73,5	50	26	•	-3026
40	85	78	50	26	•	-4026
40	85	78	50	32	•	-4032

Держатель отрезных резцов, левый

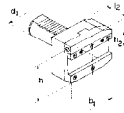

d1 mm	b1 mm	h mm	l2 mm	h2 mm	склад	№ для заказа
						47-AL
30	70	73,5	50	26	•	-3026
40	85	78	50	26	•	-4026
40	85	78	50	32	•	-4032

Тип E1, Держатель сверл

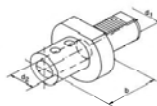

d1 mm	d2 mm	b mm	склад	№ для заказа
				47-E1
20	16	66	•	-20-16
20	20	67	•	-20-20
20	25	71	•	-20-25
25	20	67	•	-25-20
25	25	71	•	-25-25
30	10	66	•	-30-10
30	12	66	•	-30-12
30	16	66	•	-30-16
30	20	67	•	-30-20
30	25	71	•	-30-25
30	32	75	•	-30-32
40	10	66	•	-40-10
40	12	66	•	-40-12
40	16	66	•	-40-16
40	20	67	•	-40-20
40	25	75	•	-40-25
40	32	75	•	-40-32
40	40	90	•	-40-40
40	50	100	•	-40-50
50	10	67	•	-50-10
50	12	67	•	-50-12
50	16	67	•	-50-16
50	20	67	•	-50-20
50	25	80	•	-50-25
50	32	80	•	-50-32
50	40	90	•	-50-40
50	50	100	•	-50-50
60	10	80	•	-60-10
60	12	80	•	-60-12
60	16	80	•	-60-16
60	20	80	•	-60-20
60	25	80	•	-60-25
60	32	80	•	-60-32
60	40	90	•	-60-40
60	50	100	•	-60-50

Тип E2, Держатель расточных оправок

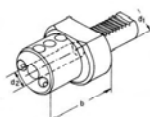

d1 mm	d2 mm	b mm	склад	№ для заказа
				47-E2
16	6	44	•	-16-6
16	8	44	•	-16-08
16	10	44	•	-16-10
16	12	44	•	-16-12
16	16	44	•	-16-16
20	8	50	•	-20-08
20	10	50	•	-20-10
20	12	50	•	-20-12
20	16	50	•	-20-16
20	20	50	•	-20-20
20	25	60	•	-20-25
25	8	50	•	-25-08
25	10	50	•	-25-10
25	12	50	•	-25-12
25	16	50	•	-25-16
25	20	50	•	-25-20
25	25	60	•	-25-25
30	8	60	•	-30-08
30	10	60	•	-30-10
30	12	60	•	-30-12
30	16	60	•	-30-16
30	20	60	•	-30-20
30	25	60	•	-30-25
30	32	75	•	-30-32
40	6	75	•	-40-6
40	8	75	•	-40-08
40	10	75	•	-40-10
40	12	75	•	-40-12
40	16	75	•	-40-16
40	20	75	•	-40-20
40	25	75	•	-40-25
40	32	75	•	-40-32
40	40	90	•	-40-40
40	50	90	•	-40-50
50	10	75	•	-50-10
50	12	90	•	-50-12
50	16	90	•	-50-16
50	20	90	•	-50-20
50	25	90	•	-50-25
50	32	90	•	-50-32
50	40	90	•	-50-40
50	50	100	•	-50-50
60	12	90	•	-60-12
60	16	90	•	-60-16
60	20	90	•	-60-20
60	25	90	•	-60-25
60	32	90	•	-60-32
60	40	90	•	-60-40
60	50	100	•	-60-50

Другие диаметры по запросу!

Тип E3, Держатель с цанговым патроном OZ, для цанг по DIN 6388



d1 mm	d3 mm	OZ	д-зон зажима	b mm	склад	№ для заказа
						47-E3
16	40	415 E	2-16	65	•	-16-16
20	50	415 E	2-16	57	•	-20-16
20	50	415 E	2-20	62	•	-20-20
25	58	415 E	2-16	57	•	-25-16
30	68	462 E	2-25	75	•	-30-25
40	83	462 E	2-25	75	•	-40-25
40	83	467 E	4-32	90	•	-40-32
50	98	462 E	2-25	75	•	-50-25
50	98	467 E	4-32	90	•	-50-32
60	123	467 E	4-32	90	•	-60-32

Тип E4, Держатель с цанговым патроном ER, для цанг по DIN 6499

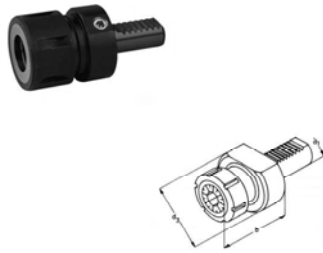

d1	d3	ER	Д-зон зажима	b	склад	№ для заказа
mm	mm			mm		
						47-E4
16	40	ER 16	1-10	40	•	-16-16
16	40	ER 20	1-13	44	•	-16-20
20	50	ER 16	1-10	40	•	-20-16
20	50	ER 25	1-16	54	•	-20-25
25	58	ER 25	1-16	57	•	-25-25
25	58	ER 32	2-20	62	•	-25-32
30	68	ER 25	1-16	57	•	-30-25
30	68	ER 32	2-20	62	•	-30-32
30	68	ER 40	2-25	70	•	-30-40
40	83	ER 25	1-16	70	•	-40-25
40	83	ER 32	2-20	84	•	-40-32
40	83	ER 40	2-25	75	•	-40-40
50	98	ER 32	2-20	84	•	-50-32
50	98	ER 40	2-25	90	•	-50-40
60	123	ER 40	2-25	75	•	-60-40

Тип E2S, Держатель разрезной, антивибрационный

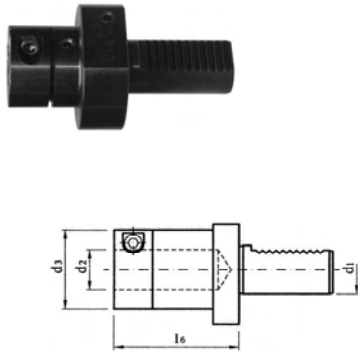

Тип	d1	d2	d3	l6	склад	№ для заказа
	мм	мм	мм	мм		
						47-E2S
30 x 6	30	6	30	57	•	-30-06
30 x 8	30	8	30	57	•	-30-08
30 x 10	30	10	36	57	•	-30-10
30 x 12	30	12	36	57	•	-30-12
30 x 16	30	16	40	57	•	-30-16
30 x 20	30	20	44	57	•	-30-20
30 x 25	30	25	49	72	•	-30-25
30 x 32	30	32	56	72	•	-30-32
40 x 10	40	10	36	62	•	-40-10
40 x 12	40	12	36	62	•	-40-12
40 x 16	40	16	40	62	•	-40-16
40 x 20	40	20	44	62	•	-40-20
40 x 25	40	25	49	77	•	-40-25
40 x 32	40	32	56	77	•	-40-32
40 x 40	40	40	64	77	•	-40-40
50 x 20	50	20	44	90	•	-50-20
50 x 25	50	25	49	90	•	-50-25
50 x 32	50	32	56	90	•	-50-32
50 x 40	50	40	64	90	•	-50-40

Тип F, Держатель инструмента с конусом Морзе

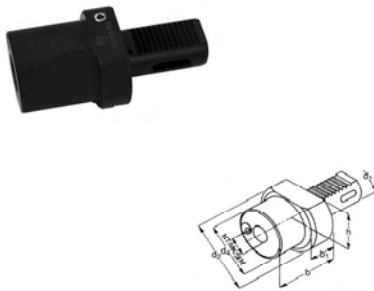

Тип	d1	d2	d3	l6	склад	№ для заказа
	мм	мм	мм	мм		
						47-
20	1	23	50	22	•	-F20-1
20	2	23	50	90	•	-F20-2
25	1	25	58	22	•	-F25-1
25	2	25	58	46	•	-F25-2
30	1	28	68	27	•	-F30-1
30	2	28	68	36	•	-F30-2
30	3	28	68	66	•	-F30-3
40	1	32,5	83	36	•	-F40-1
40	2	32,5	83	36	•	-F40-2
40	3	32,5	83	50	•	-F40-3
40	4	32,5	83	80	•	-F40-4
50	2	35	98	36	•	-F50-2
50	3	35	98	45	•	-F50-3
50	4	35	98	55	•	-F50-4
50	5	35	98	68	•	-F50-5
60	3	42,5	123	36	•	-F60-3
60	4	42,5	123	50	•	-F60-4
60	5	42,5	123	81	•	-F60-5



Устройство подачи прутка

- для двух зажимаемых диапазонов
- с двусторонними кулачками

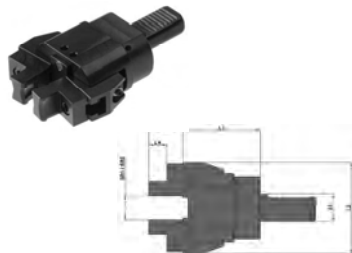

d1 mm	зжимаемый диапазон		L1 mm	L2 mm	L3 mm	L4 mm	склад	№ для заказа
	1	2						47
20	6-45	45-100	59	99	34	18	•	-SGF20
30	6-45	45-100	59	99	34	18	•	-SGF30
цил. 32	6-45	45-100	59	99	34	18	•	-SGF32Z
40	6-56	56-110	61	111	34	18	•	-SGF40
50	6-56	56-110	61	111	34	18	•	-SGF50

Резьбонарезной патрон с осевой компенсацией

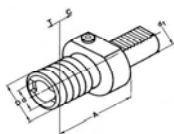

размер	d1 mm	диапазон резьб	A mm	D mm	d mm	склад	№ для заказа
							76-GSSF
1	20	M3 / M14	55	38	19	•	-VDI20/1
1	25	M3 / M14	55	38	19	•	-VDI25/1
1	30	M3 / M14	55	38	19	•	-VDI30/1
2	30	M5 / M22	77	54	31	•	-VDI30/2
1	40	M3 / M14	55	38	19	•	-VDI40/1
2	40	M5 / M22	77	54	31	•	-VDI40/2
1	50	M3 / M14	55	38	19	»	-VDI50/1
2	50	M5 / M22	77	54	31	»	-VDI50/2
3	50	M14 / M36	108	78	48	»	-VDI50/3

Универсальный сверлильный патрон

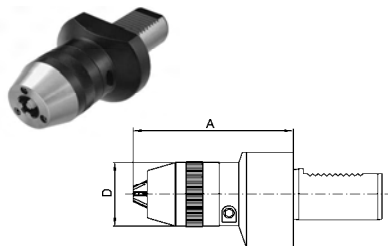

VDI	дапазон зажима	A mm	D mm	склад	№ для заказа
	mm				82
16**	1-10	41	50	»	-341016
20**	1-10	41	50	»	-341020
30	1-13	87	50	•	-341330
30	1-13	92	55	•	-341630
40	1-13	88	50	•	-341340
40	1-16	93	55	•	-341640
50	1-16	101,5	55	»	-341650

Тестовая оправка DIN69880

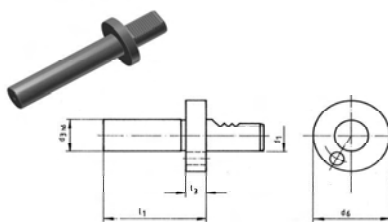

d1 mm	d3 mm	d6 mm	l1 mm	l3 mm	склад	№ для заказа
						47-PD
16	30	40	120	15	»	-16-30
20	40	50	150	15	»	-20-40
25	40	58	150	15	»	-25-40
30	40	68	200	15	•	-30-40
40	40	83	200	15	•	-40-40
50	40	98	200	15	•	-50-40
60	40	123	200	15	»	-60-40

Защитные заглушки Z2



d mm	D mm	l mm	склад	№ для заказа
				47-Z2
16	40	13	•	-16K
20	50	16	•	-20K
25	58	16	•	-25K
30	68	16	•	-30K
40	83	20	•	-40K
50	98	20	•	-50K
60	123	20	•	-60K

Переходные втулки, разрезные

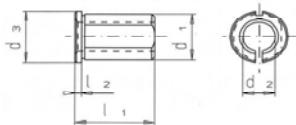

d1	d2	d3	l1	l2	склад	№ для заказа
mm	mm	mm	mm	mm		47-RZ
20	8	24	50	4	•	-20-8
20	10	24	50	4	•	-20-10
20	12	24	50	4	•	-20-12
20	14	24	50	4	•	-20-14
20	15	24	50	4	•	-20-15
20	16	24	50	4	•	-20-16
25	8	29	50	4	•	-25-8
25	10	29	50	4	•	-25-10
25	12	29	50	4	•	-25-12
25	14	29	50	4	•	-25-14
25	15	29	50	4	•	-25-15
25	16	29	50	4	•	-25-16
25	18	29	50	4	•	-25-18
25	20	29	50	4	•	-25-20
32	8	36	60	4	•	-32-8
32	10	36	60	4	•	-32-10
32	12	36	60	4	•	-32-12
32	14	36	60	4	•	-32-14
32	15	36	60	4	•	-32-15
32	16	36	60	4	•	-32-16
32	18	36	60	4	•	-32-18
32	20	36	60	4	•	-32-20
32	25	36	60	4	•	-32-25
40	10	44	75	4	•	-40-10
40	12	44	75	4	•	-40-12
40	14	44	75	4	•	-40-14
40	15	44	75	4	•	-40-15
40	16	44	75	4	•	-40-16
40	18	44	75	4	•	-40-18
40	20	44	75	4	•	-40-20
40	25	44	75	4	•	-40-25
40	32	44	75	4	•	-40-32
50	20	54	75	4	•	-50-20
50	25	54	75	4	•	-50-25
50	32	54	75	4	•	-50-32
50	40	54	75	4	•	-50-40
60	25	64	75	4	▶	-60-25
60	32	64	75	4	▶	-60-32
60	40	64	75	4	▶	-60-40
60	50	64	75	4	▶	-60-50

Приспособления для сборки инструмента

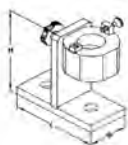

размер	L	H	B	склад	№ для заказа
	mm	mm	mm		47-MBS
VDI 16	100	97	48	▶	-16
VDI 20	100	97	48	▶	-20
VDI 25	100	97	48	▶	-25
VDI 30	130	121	64	▶	-30
VDI 40	130	136	64	▶	-40
VDI 50	170	170	72	▶	-50